



# 

## MANUAL / QUICK START GUIDE



### IMPORTANT LINKS:

- Link to the most recent version of this manual:  
[redcatracing.com/pages/manuals](http://redcatracing.com/pages/manuals)

# WARNING!

Fully read all instructions, manuals and warnings that come with your RC vehicle and any accessories required to operate the product.

## AGE WARNING!

This radio controlled (RC) vehicle is not a toy. It is the responsibility of the parents or guardian to ensure that minors receive appropriate guidance and supervision when operating or working on this product.

It is the buyer's responsibility to ensure that this product is safely operated. You must be 14 years of age or older to operate this vehicle.

The buyer assumes all risks associated with the use of this product. Namero LLC d/b/a Redcat Racing and their retail partners, dealers, distributors, manufactures and affiliates cannot control the use and operation of this product and as such shall not be held responsible or liable for any injury, accident or damage resulting from the use of this product.

Never operate your RC vehicles on public roads, near bystanders, children, pets or other animals.

Always leave a safe distance around your RC vehicles when driving so that in the event you lose control, you don't damage the vehicle, hurt yourself or hurt others.

Never lose sight of your vehicle while it is in operation and be aware of your surroundings.

Always keep clear of the wheels or other moving parts on the vehicle and never attempt to pick up the vehicle when the wheels are in motion.

Always perform a pre-run inspection to ensure that there is no damage and that all screws and wheel nuts are secure. If damage is found, repair or replace prior to use.

Do not attempt to touch the motor, ESC, battery or other electrical components during or immediately after use, as these items will get hot during operation.

Always allow the vehicle time to cool down between runs. Overheating the electronics can shorten the life of the electronic components.

Never leave the battery connected when not in use.

Always store battery packs in a cool dry place.

Never leave a battery unattended while being charged. Never charge batteries while they are inside of the RC vehicle.

There is a risk of fire and explosion when dealing with batteries. Rechargeable batteries may become hot and catch fire if left unattended or charged too quickly.

Always use extra caution when charging LiPo batteries.

Only use LiPo specific chargers when charging LiPo batteries.

Always use a LiPo safe charging pouch when charging LiPo batteries.

Always charge batteries away from flammable materials and in a well ventilated space.

Never charge at a rate higher than 1C. (2000Mah pack= 2 amp charge rate). Overcharging can lead to fire and explosion.

Never use a LiPo battery that has previously overheated and/or shows signs of damage or swelling. If you suspect the battery to be damaged, immediately discontinue use and properly dispose of the battery.

Never dispose of a LiPo battery with the regular trash. To safely dispose of LiPo batteries, refer to your local disposal authority or recycling center.

Always check the ESC settings to ensure that they match the battery type during operation. If using a LiPo battery, the ESC must be set to LiPo or damage may occur.

Never mix old and new batteries. Do not change or charge batteries in a hazardous location. Do not mix alkaline, lithium, standard (carbon zinc), or rechargeable (NiMH, cadmium) batteries.

If you do not agree with or are unable to follow these warnings and are not willing to accept full and complete liability for the use of this RC product; immediately return the product to your place of purchase in new and unused condition.

# Practice Required:

Beginners should start slowly. Keep practicing until you feel comfortable with steering, throttle, and brakes. Once you feel comfortable driving the vehicle try a different terrain and speed until you have mastered the basics.

Once you have learned the basics, try different patterns and tracks to improve your skills.

Add a friend for a race or try to beat your best times!

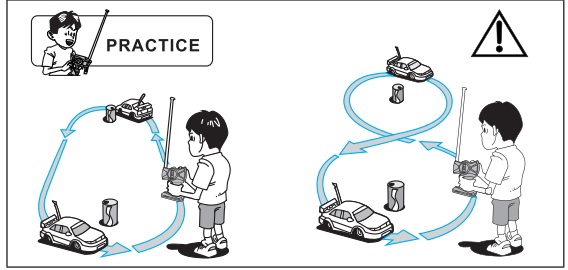

# 2.4GHz Transmitter Introduction:



- 1) Steering Wheel
- 2) Throttle Trigger
- 3) Steering Trim
- 4) Steering Direction Reverse Switch
- 5) Speed Selection
- 6) LED
- 7) Power ON/OFF
- 8) AUX. Button  
(This button is disabled)

## Brushed ESC/Receiver:

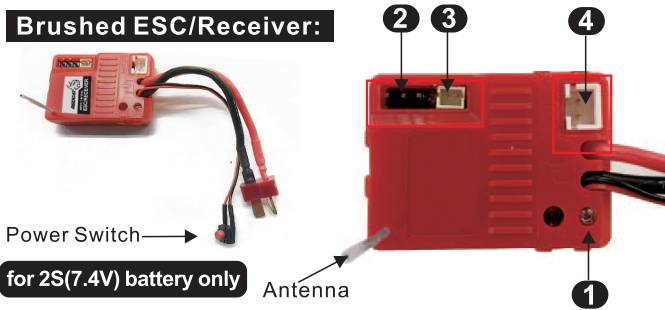

Power Switch:  
Press and hold for 2-3 seconds to switch on or off.

- 1) Power Indicator
- 2) Servo Slot (3-pin)  
(for 3-wire Servo)
- 3) Aux. Slot (for optional LED light)
- 4) Motor Plug Slot

**Always straighten the antenna for the best performance.**

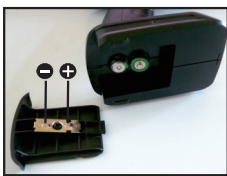

Slide and remove the battery cover from the transmitter, install two AA size batteries (1.5V, each), and replace the battery cover. Do not reverse the polarities when installing. Always use batteries of same brand and remove batteries when not in use. Make sure battery power is sufficient before use.

**Please replace the batteries for the transmitter if the transmitter LED blinks slowly.**

# Turning ON the vehicle:

## 1) Switch on the Transmitter:

Slide the Power Switch to "ON" position. Make sure the transmitter has enough battery power. Please insert new transmitter batteries if the LED on the transmitter blinks slowly. **Do NOT move the trigger and the steering wheel while the transmitter is binding.**



## 2) Switch on the ESC/Receiver:

Press and hold the Power Switch on ESC/Receiver for 2-3 seconds to turn on the car. It will take a few seconds before both LEDs (on Transmitter and the ESC/Receiver) stop blinking and become solid, which indicates that the car is bound with the transmitter.

Binding may fail if the battery is low on power. Please stop and charge the battery pack once the car jerks, cogs, or moves slowly. If the battery is dead, the car may have steering but no throttle. If the car runs harshly or makes a lot of noise, stop and check that there is nothing binding the drivetrain.

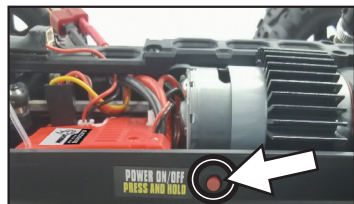

Press and hold for 2-3 seconds to switch on

## 3) Check the steering performance by turning the steering wheel:

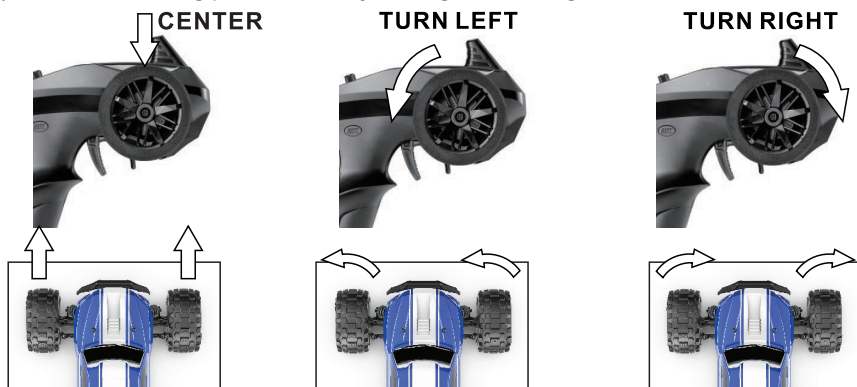

A) With the steering wheel centered, the vehicle runs in a straight line.

Slight adjustments by turning the steering wheel may be needed to drive in a straight line. It largely depends on the terrains that you drive.

B) Turn the steering wheel to the left, and the car steers left.

C) Turn the steering wheel to the right, and the car steers right.

## 4) Throttle Control:

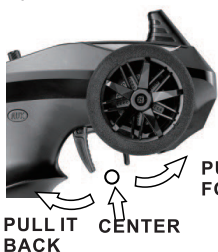

Pull the trigger to accelerate, release it to reduce speed, and push to brake. Put the trigger in the Center Position and push it forward again to go in reverse.

### 5) Steering Trim Knob:



STEERING TRIM

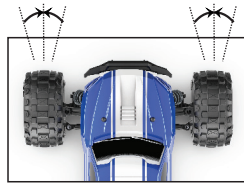

It is used to set the steering neutral point of the front wheels. If the front wheels on the vehicle veer in one direction while the steering wheel is centered, turn this knob in the opposite direction until the vehicle tracks straight.

### 6) Speed Switch Knob:



SPEED SWITCH

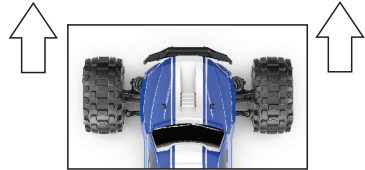

The Speed Switch is actually the throttle limiter. Turning down the knob all the way will reduce the maximum speed down to 40% while at maximum throttle. Turning the knob all the way up will increase max speed up to 100% while at maximum throttle. It is advisable to operate the vehicle on the slower setting until you have had plenty of practice driving.

### 7) Steering Direction Reverse Switch:



STEERING REVERSE

If the vehicle turns right when you steer left, flip the "Steering Reverse" switch. If the vehicle turns left when you steer right, flip the "Steering Reverse" switch.

## Turning OFF the vehicle:

1) Switch off the ESC/Receiver:  
Press and hold the Power Switch for 2-3 seconds until the LED on the ESC/Receiver goes off.

2) Switch off the Transmitter:  
Slide the Power Switch to the "OFF" position.

3) Disconnect and remove the battery pack from the car when not in use.  
**Note: It is highly recommended to charge the battery to about 50% before storing.**

4) Make sure there are no damaged parts before storing the vehicle.

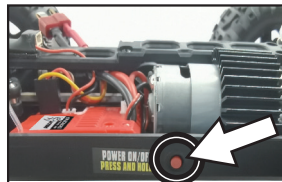

Press and hold for 2-3 seconds to switch off



# Charging The Battery Pack:

**ONLY** use the specified charger (provided in the box) to charge the battery pack.

**Note:** The USB balance charger is included in the box.

## **! WARNING!**

- Do not charge the battery pack unattended.
- Do not use damaged and/or leaky batteries or a damaged charger.
- Children are not allowed to charge the battery without being closely supervised by adults.

## **Precautions:**

- Be sure to always disconnect the battery pack and remove it from the vehicle when not in use.
- Please fully charge the battery before each use.
- Do not leave the battery pack uncharged or fully charged for long periods of time.
- Do not completely drain the battery while running the vehicle. Do not charge the battery under any wet or damp conditions. Only charge in dry conditions.

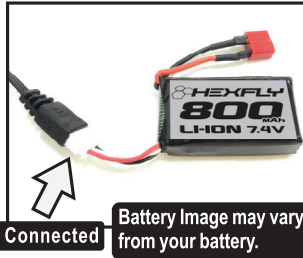
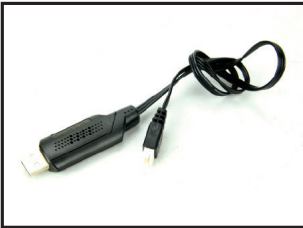

Battery Image may vary from your battery.

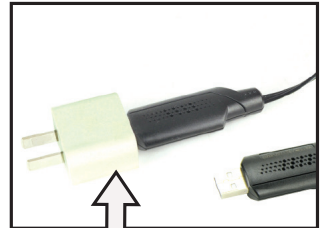

Smart phone AC Power adaptor (not Included)

During charging, the red LED is lit solid, which monitors the charging process. The red LED will go off after the battery pack has been fully charged.

**Charging Duration:** Li-ion Battery Pack 7.4V, 800 mAh (Approx. 2-2.5 hours),

**Soft Pack Li-Po Battery Pack 7.4V,1000mAh (Approx. 2.5 hours)**

Tip: Smart phone AC POWER adapters (5V,2A ) can be used to cut down on charging times.

## **The red LED flashes, which indicates:**

- 1) USB charging cable is connected with the battery pack but not plugged into the charging slot.
- 2) Non-rechargeable battery pack is connected
- 3) Not able to charge because the battery pack is over-discharged.
- 4) USB cable is in an unstable connection.

# Maintenance:

We strongly recommend that you check and maintain the vehicle after each use.

- Disconnect and remove the batteries from the vehicle and radio when not in use.
- Do not leave the rechargeable battery pack uncharged or fully charged for a long time.
- Check for any damage after each use.
- If the vehicle makes an unusual noise while running, check to see if there are any broken gears or if anything is stuck in the drive train.
- Check that the wheels are fully tightened.
- Check if there are any loose screws in the chassis.
- Check for any frayed, damaged, loosened wires, or connectors. Replace or fix.
- Check if the steering servo is working properly. It may wear out over time and require replacement.
- Completely inspect the drive train. Replace any worn out or damaged parts.
- Check the motor and motor wires after use. Never attempt to dis-assemble the motor.
- Clean the car body and chassis with a soft lint-free cloth.
- Store the vehicle in a clean, cool, and dry place out of the reach of children.

# Troubleshooting:

## **A. The vehicle does not work at all:**

- 1) Make sure both the radio and car are switched on.
- 2) Check for damaged parts/wires/connectors and repair or replace if necessary.
- 3) Car battery is dead. Charge the battery pack.

## **B. The vehicle runs slowly:**

- 1) Car battery is dead. Charge the battery pack.
- 2) Check if the vehicle is geared properly and that there aren't any dirty or stripped gears. Make sure there is proper gear mesh between the motor pinion gear and the spur gear.
- 3) Check if something is binding any of the moving parts and clean it immediately.

## **C. The throttle works but not the steering:**

- 1) Check if the servo feels jammed and if so, try centering it gently.
- 2) Check if the servo link is loose or if the servo is broken. Repair or replace if needed.

## **D. It steers, but throttle is uncontrollable:**

- 1) Check if there are damaged parts in the overall drive train.
- 2) Check the batteries in both the radio and the car.

## **E. The vehicle runs noisily:**

- 1) Check gear mesh between spur gear and motor pinion.
- 2) Check if there are stripped and/or dirty gears.
- 3) Check if there are some parts gelling damaged in the overall drive train.

## **F. The vehicle automatically steers in one direction:**

Fine tune the Steering Trim until the Steering Center Point is fixed.

## **G. Not able to charge the batteries:**

Check if either the charger or the battery is damaged. The battery may be over-discharged.

# Headlight Installation

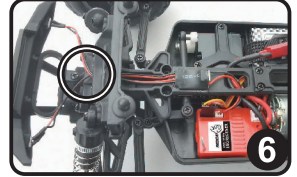
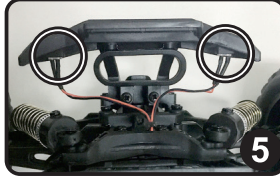
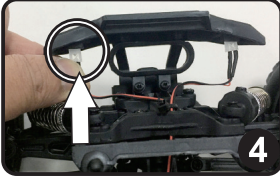
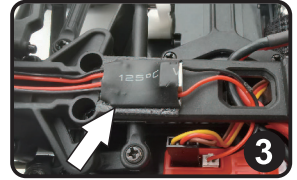
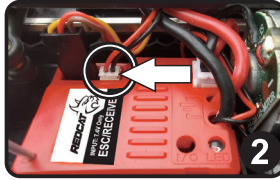
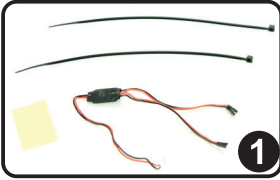

1) The headlight, which is included in the box, needs to be installed.

2) Remove the headlight, zip ties, and adhesive tape from the box. (See Photo 1)

3) Insert the headlight plug into the slot on the ESC/Receiver. (See Photo 2).

Note: Do not force while plugging or unplugging.

4) Apply some adhesive tape to the headlight board and stick it on the upper chassis deck as shown. (See Photo 3)

5) Gently insert the headlights into the slots on the back of the front bumper. Make sure they are in place. (See Photo 4 and Photo 5)

6) Secure the wires with the included wire ties. (See Photo 6)



# Decal Guide

Be sure to remove the clear protective body film BEFORE applying decals.

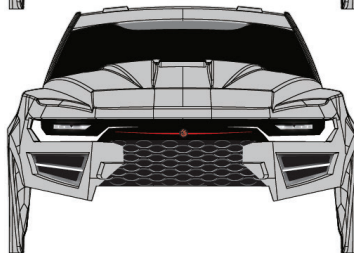
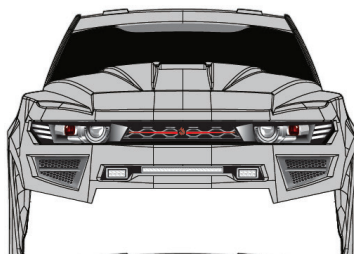
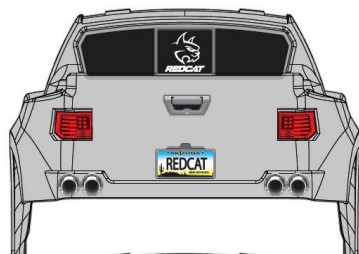
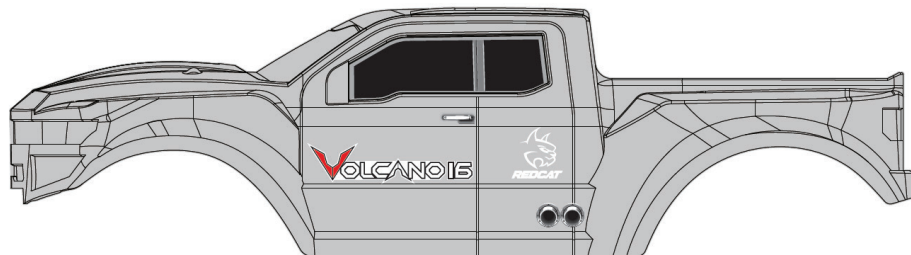
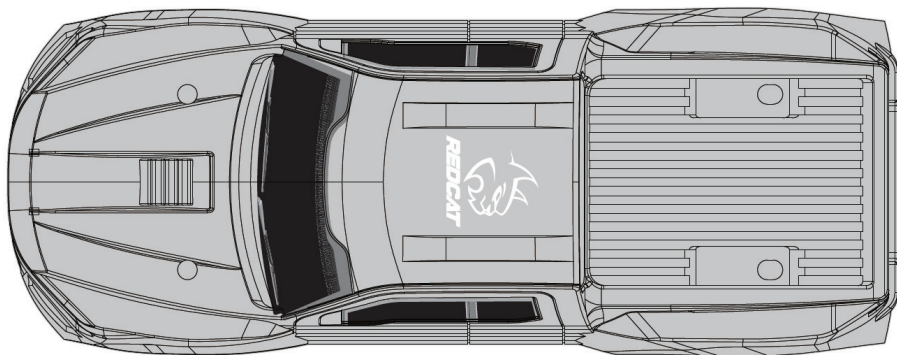





















**PART LIST-1**

<b>RER13616</b>	<b>RER13618</b>	<b>RER13619</b>	<b>RER13620</b>
			
Chassis	Front Gear Box Top Housing	Rear Gear Box Top Housing	Front Bumper Assembly
<b>RER13621</b>	<b>RER13622</b>	<b>RER13623</b>	<b>RER13624</b>
			
Rear Bumper Assembly	Front Lower Suspension Arms(Left/Right)	Front Upper Suspension Arms(Left/Right)	Rear Lower Suspension Arms(Left/Right)
<b>RER13625</b>	<b>RER13626</b>	<b>RER13627</b>	<b>RER13628</b>
			
Steering links+Servo Link+Rear Upper Suspension Arms	Shock Towers(Front and Rear)	Body Posts	Shock Absorbers(2P)
<b>RER13629</b>	<b>RER13630</b>	<b>RER13631</b>	<b>RER13632</b>
			
Steering Hubs	Rear Hubs	Front/Rear Drive Shafts	Diff. Outdrive Cups
<b>RER13633</b>	<b>RER13634</b>	<b>RER13635</b>	<b>RER13636</b>
			
Steering Bushes+Ackerman Plate	Diff. Complete (Front/rear)	Servo Top Plate+Motor Guard	Spur Gear+Drive Pinions



**PART LIST-2**

RER13637	RER13638	RER13639	RER13640
 <p>Servo Saver Assembly</p>	 <p>Centre Drive Shaft</p>	 <p>Front /Rear Upper SuspensionHinge Bolts</p>	 <p>Front/Rear Lower Suspension Hinge Pins</p>
RER13641	RER13642	RER13643	RER13644
 <p>Rear Hub Pins (4P)</p>	 <p>Wheel Hex. Pins (8P)</p>	 <p>Diff. Assembly</p>	 <p>Steering Posts (4P)</p>
RER13645	RER13646	RER13647	RER15186
 <p>Diff. Posts+Pins</p>	 <p>Steering Pivot Balls (8P)</p>	 <p>Plastic Pivot Balls Complete</p>	 <p>Electronic Speed Control/Receiver</p>
RER15187	RER13653	RER13654	RER13655
 <p>Servo (3-wire)</p>	 <p>Motor 390</p>	 <p>Motor Pinions(14T) +Set Screw</p>	 <p>Motor Heatsink</p>
RER13656	RER13657	RER13658	RER13659
 <p>Battery Pack(Li-ion 7.4V,800mAH), W/Dean Plug</p>	 <p>Wheels Complete</p>	 <p>Volcano Truck Body (Blue)</p>	 <p>Volcano Truck Body (Red)</p>

**PART LIST-3**

<p><b>RER13660</b></p>  <p>Battery Binding Strap</p>	<p><b>12010</b></p>  <p>Wheel Hex.</p>	<p><b>P010</b></p>  <p>Zip Ties (8P)</p>	<p><b>RER13673</b></p>  <p>Body Clips (2 pairs)</p>
<p><b>18859E-E001</b></p>  <p>USB charger</p>	<p><b>793127</b></p> <p><b>8P</b></p>  <p>Ball Bearings (φ7.93*12.7*3.95mm)</p>	<p><b>RER13661</b></p> <p><b>8P</b></p>  <p>Ball Bearings (φ6.35*9.53*3.17mm)</p>	<p><b>RER13662</b></p> <p><b>8P</b></p>  <p>Wheel Lock Blots</p>
<p><b>BS901-055RR</b></p> <p><b>12P</b></p>  <p>2X8 Button Head Phillips Self Tapping Screws</p>	<p><b>S029</b></p> <p><b>12P</b></p>  <p>Pan Head Self Tapping Screws PBHO2.6*10mm</p>	<p><b>RER13663</b></p> <p><b>12P</b></p>  <p>Countersunk Screws KM2.5*8</p>	<p><b>RER13664</b></p> <p><b>12P</b></p>  <p>Countersunk Self Tapping KBHO2.6*12mm</p>
<p><b>S103</b></p> <p><b>12P</b></p>  <p>Set Screw 2.5x2.5mm</p>	<p><b>RER13666</b></p> <p><b>12P</b></p>  <p>Countersunk Self Tapping Screws KBHO2.3*6mm</p>	<p><b>RER13667</b></p> <p><b>12P</b></p>  <p>Pan head Self Tapping Screws PBHO2.6*12mm</p>	<p><b>RER13668</b></p> <p><b>12P</b></p>  <p>Pan head Self Tapping Screws PBHO2*12mm</p>
<p><b>RER13670</b></p> <p><b>12P</b></p>  <p>Pan head Self Tapping Screws PBHO2.3*4mm</p>	<p><b>RER13671</b></p> <p><b>12P</b></p>  <p>Countersunk Self Tapping Screws KBHO2.3*12mm</p>	<p><b>RER13672</b></p> <p><b>12P</b></p>  <p>Flange Head Self Tapping Screws PWTHO2.6*12mm</p>	<p><b>16014</b></p> <p><b>8P</b></p>  <p>Steering Hub Step Screws</p>

**PART LIST-4**

<p><b>12670-2.4G</b></p>  <p>2.4GHz Radio Control</p>	<p><b>RER13674</b></p>  <p>Headlight LED</p>		
<p><b>RER13675</b></p> <p><b>OPTIONAL</b></p>  <p>Aluminum Capped Oil Filled Shocks</p>	<p><b>RER13676</b></p> <p><b>OPTIONAL</b></p>  <p>Heavy Duty Center Drive Shaft + Outdrive Cups + Pins + Screws (suited for metal spur gear version)</p>	<p><b>RER13677</b></p> <p><b>OPTIONAL</b></p>  <p>Machined Metal Spur Gear</p>	<p><b>RER13678</b></p> <p><b>OPTIONAL</b></p>  <p>Machined Metal Diff. Gears + Diff. Pinions</p>
<p><b>RER13680</b></p> <p><b>OPTIONAL</b></p>  <p>Machined Metal Diff. Outdrive Cups + Pins</p>	<p><b>RER13681</b></p> <p><b>OPTIONAL</b></p>  <p>Metal Front CVD Shafts + Pins + Lock Nut M4</p>	<p><b>RER13682</b></p> <p><b>OPTIONAL</b></p>  <p>Metal Rear Dogbones</p>	<p><b>RER13683</b></p> <p><b>OPTIONAL</b></p>  <p>Metal Rear Wheel Shafts + Pins + Lock Nut M4</p>
<p><b>RER13684</b></p> <p><b>OPTIONAL</b></p>  <p>Wheelie Bar Assembly</p>	<p><b>RER13688</b></p> <p><b>OPTIONAL</b></p>  <p>Battery Pack (Li-ion 7.4V, 1300mAh), W/Dean Plug</p>		

# ASSEMBLY VIEW-1

## SHOCK ASSEMBLY

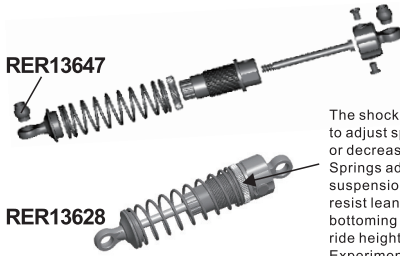

The shock absorbers are fitted with a threaded ring to adjust spring tension (preload). You can increase or decrease the spring tension by adjusting the ring. Springs adjusted to the correct length allow the suspension to hold the weight of the car properly, resist leaning into turns, prevent the chassis from bottoming out, increase traction, and fine tune the ride height. Make sure the preload is the same on both sides. Experiment with different settings and positions to get the best results.

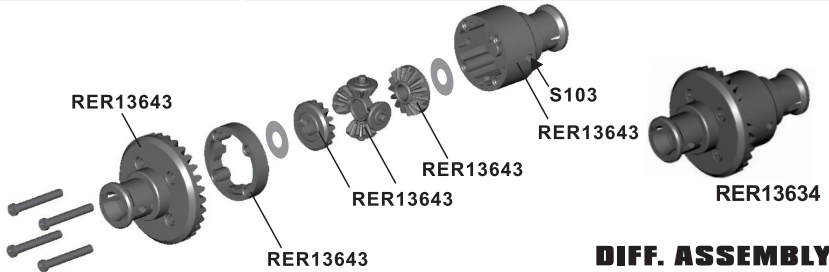
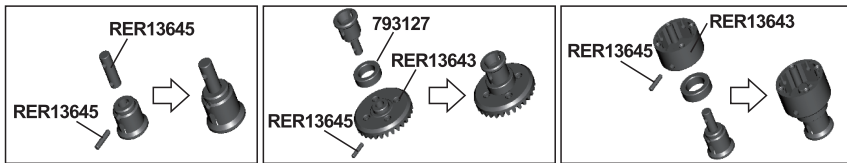

## DIFF. ASSEMBLY

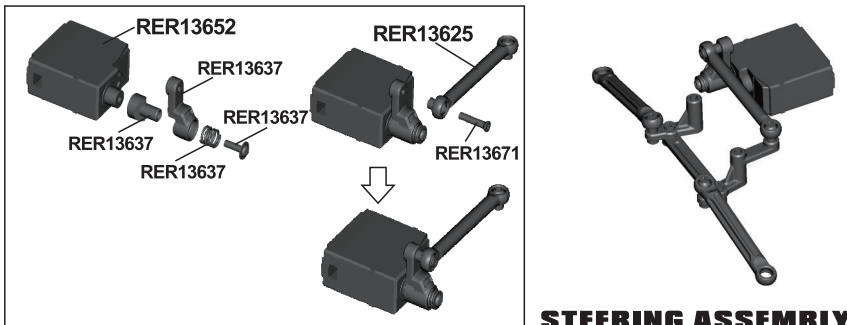
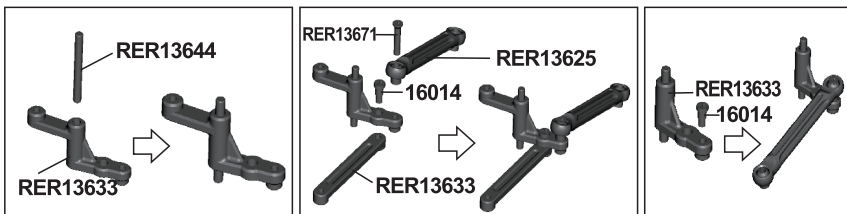

## STEERING ASSEMBLY

## ASSEMBLY VIEW-2

### CENTER DRIVE ASSEMBLY

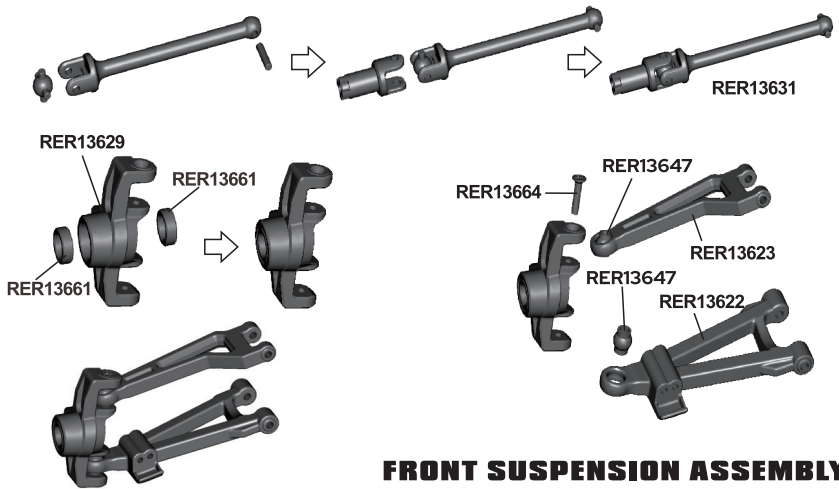
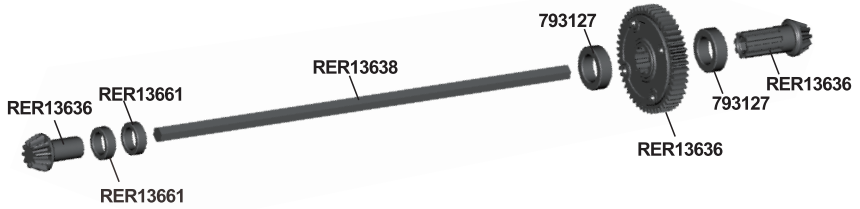

### FRONT SUSPENSION ASSEMBLY

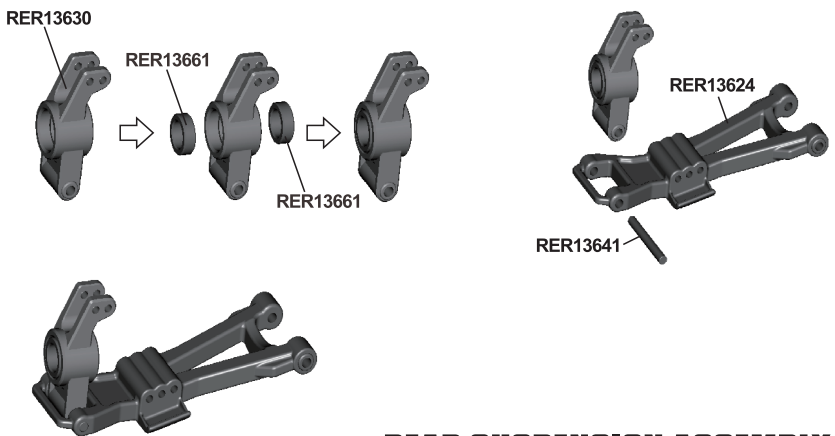

### REAR SUSPENSION ASSEMBLY

### ASSEMBLY VIEW-3

#### FRONT/REAR SHOCK TOWER BODY POST ASSEMBLY

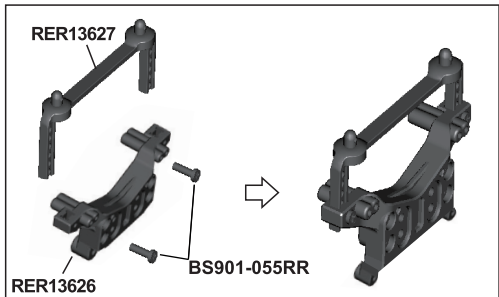
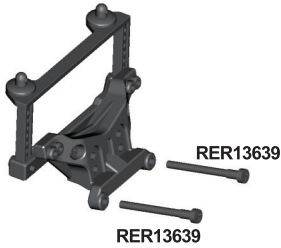
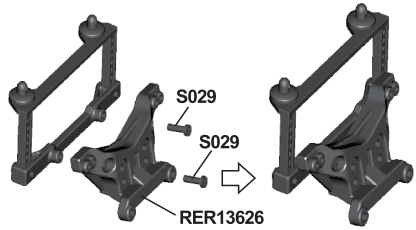
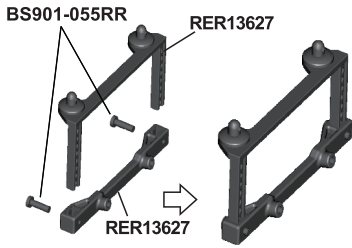

#### BUMPER ASSEMBLY

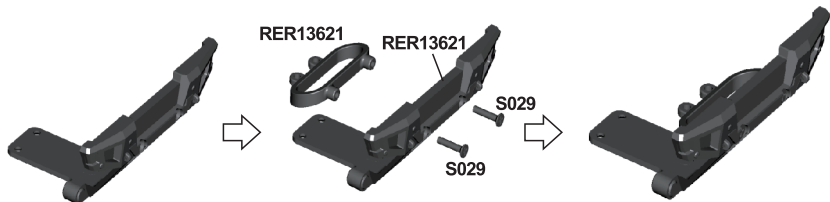
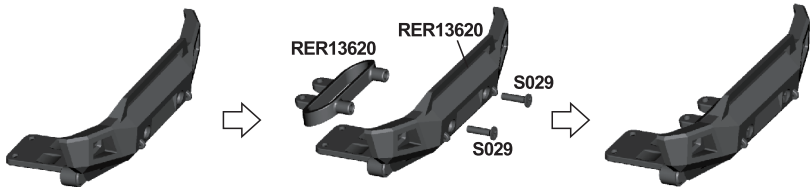



# ASSEMBLY VIEW-4

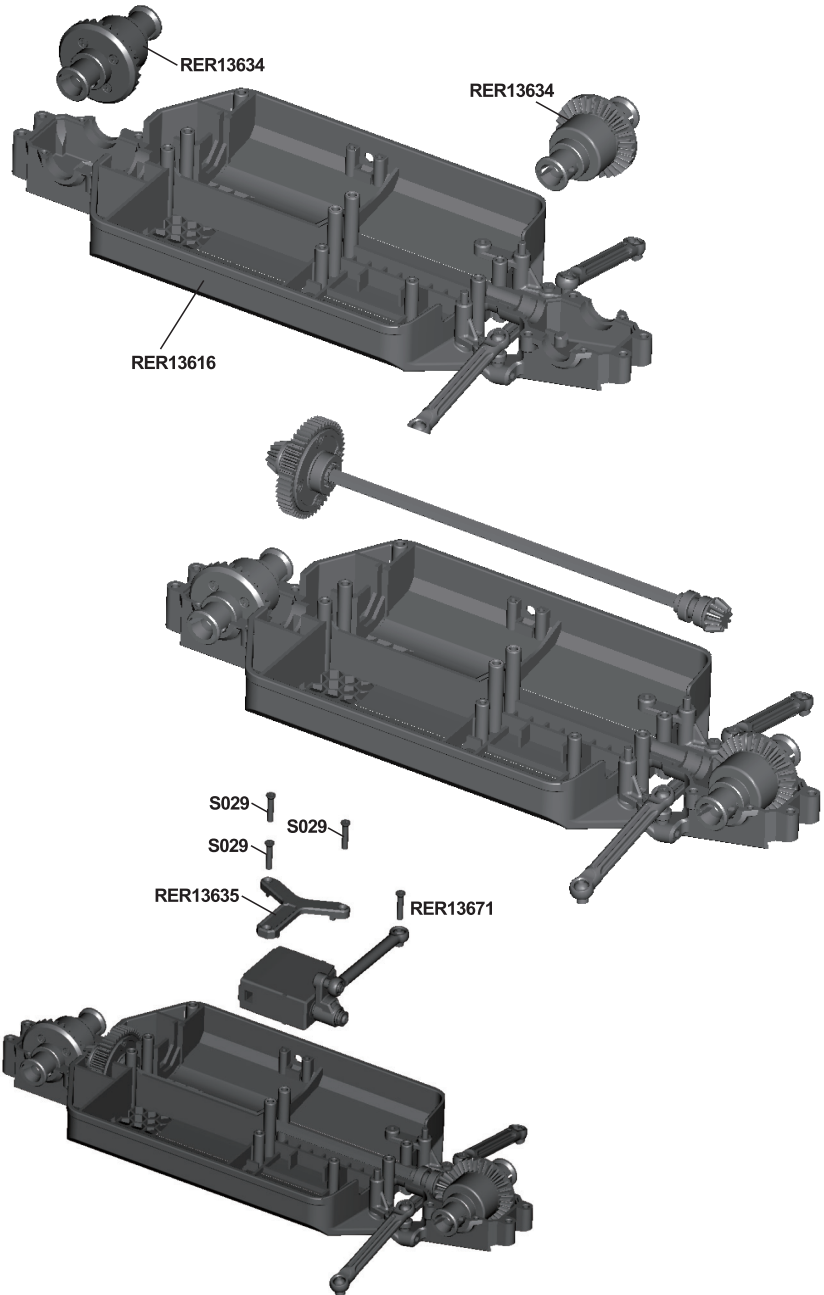

# ASSEMBLY VIEW-5

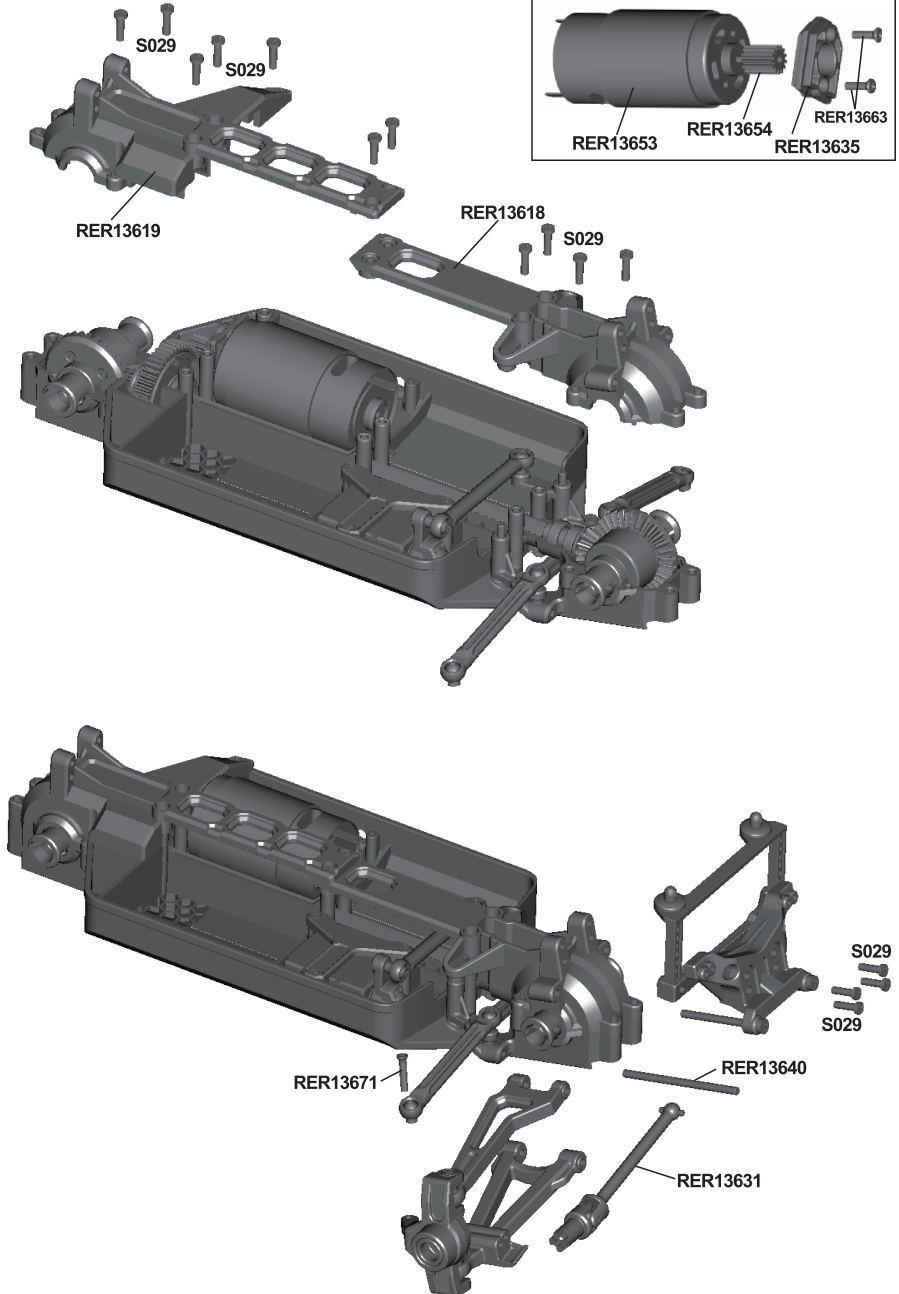

### ASSEMBLY VIEW-6

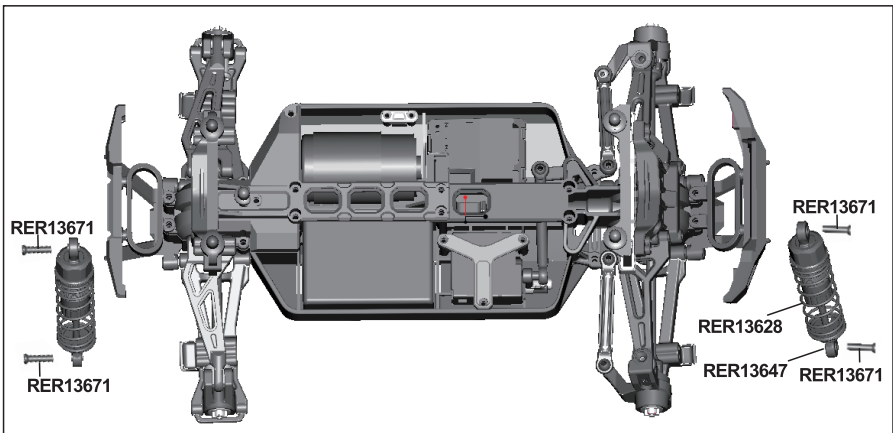
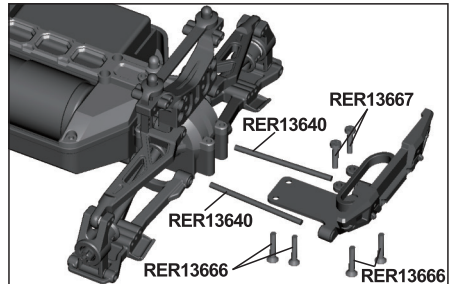
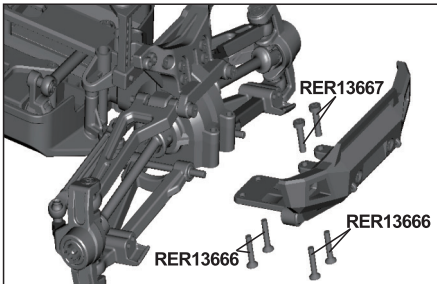
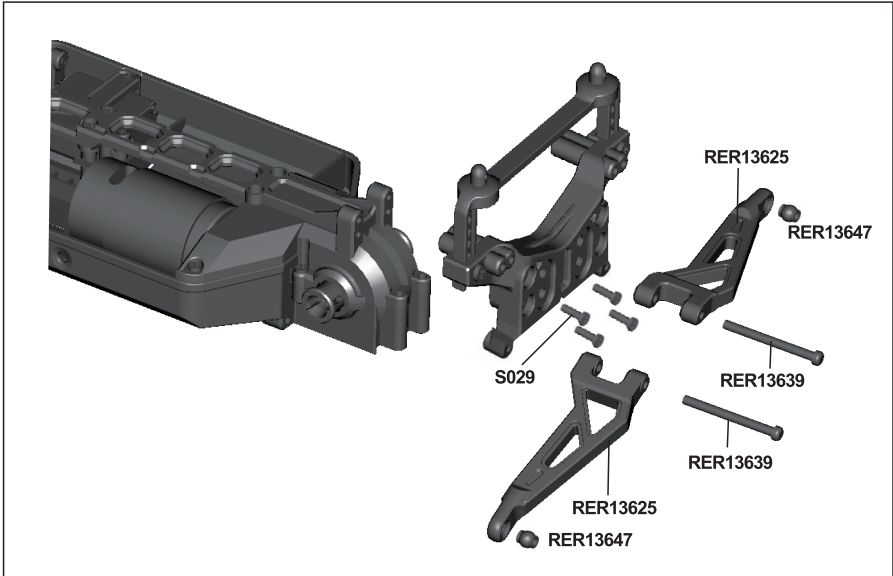

### ASSEMBLY VIEW-7

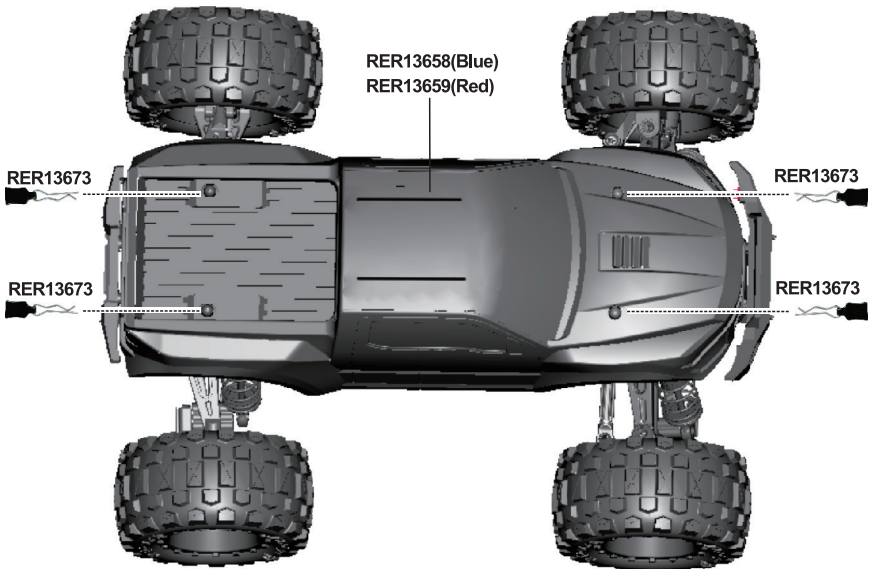
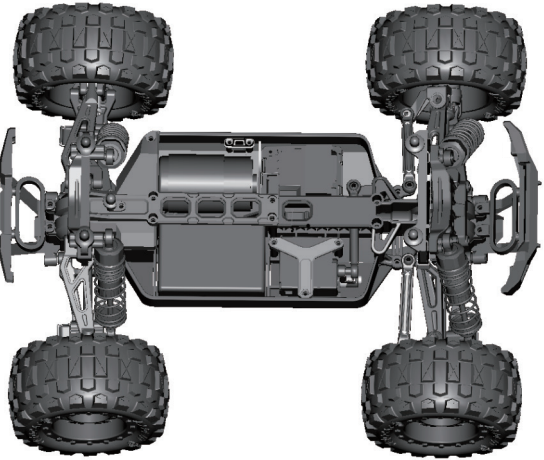
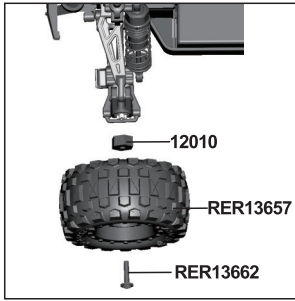



**[www.redcatracing.com](http://www.redcatracing.com)**

Follow us on social media

Take a photo, create a video, post and share your Redcat experience.

Stay up to date on the latest Redcat news, products, and creative content. While these profiles are not customer service channels, you might find that one of our subject experts or another member of the community is able to assist you. If you have an issue or need technical and or product support, please reach out to Redcat directly through our website.

 [www.facebook.com/redcatracing](http://www.facebook.com/redcatracing)

 [www.instagram.com/redcatracing](http://www.instagram.com/redcatracing)

 [www.youtube.com/redcatracing](http://www.youtube.com/redcatracing)

 [www.twitter.com/redcatracing](http://www.twitter.com/redcatracing)

 [www.pinterest.com/redcatracing](http://www.pinterest.com/redcatracing)

#### **IMPORTANT LINKS:**

- Link to the most recent version of this manual with parts and exploded views:  
[redcatracing.com/pages/manuals](http://redcatracing.com/pages/manuals)